

SINGER

246-20

FOR

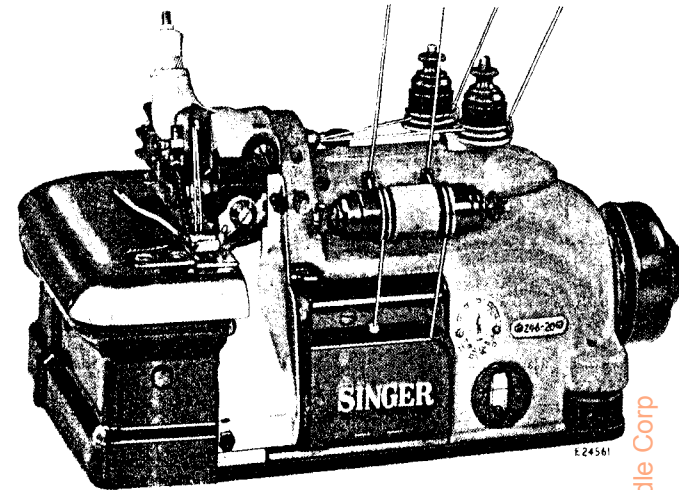

MACHINE No. 246-20

FOR TRIMMING AND OVEREDGING BATHING SUITS, HOUSE DRESSES AND SIMILAR ARTICLES. TWO NEEDLES, TWO LOOPERS. MAKES A FOUR-THREAD DUAL-STITCH. DISTANCE BETWEEN NEEDLES IS FIXED AT .109 INCHES. BIGHT 3/32" TO 7/32" FROM NEEDLE. MATERIAL UP TO 1/4 INCH IN THICKNESS CAN BE STITCHED. SPEED UP TO 5000, DEPENDING ON MATERIALS USED AND OPERATIONS PERFORMED.

No.	Plate	Name
164864	24881	Chain Cutter Chain Retainer (spring).
665J	24881	Chain Cutter Chain Retainer (spring) Screw
164865	24881	Chain Cutter with Chain Retainer complete, Nos. 164861, 164863, 164864 and two 665J
164863	24881	Chain Cutter Holder
164861	24881	Chain Cutter Knife
665J	24881	Chain Cutter Knife Screw
164001	24878	Chip Guard
1209J	24878	Chip Guard Screw (lower)
140509J	24878	Chip Guard Screw (upper)
164613	24878	Cloth Plate
164002	24878	Cloth Plate Extension
51408J	24878	Cloth Plate Extension Screw (2)
1700J	24878	Cloth Plate Extension Screw Nut
931084	24878	Cloth Plate Extension Screw Nut Lock Washer
164205	24878	Cloth Plate Lock Spring
1700J	24878	Cloth Plate Lock Spring Nut
931084	24878	Cloth Plate Lock Spring Nut Lock Washer
1250AL	24878	Cloth Plate Lock Spring Screw Stud
164104	24878	Cloth Plate Plunger
164105	24878	Cloth Plate Plunger Spring
624AL	24878	Cloth Plate Plunger Set Screw
164106	24878	Cloth Plate Position Collar with two 624AL
624AL	24878	Cloth Plate Position Collar Set Screw (2)
164614	24878	Cloth Plate with Extension complete, Nos. 164002, 164205, 164613 and two each 1700J, 51408J and 931084

82262

From the Library of: Diamond Needle Corp

No.	Plate	Name
164003	24879	Feed Bar Hinge Pin (eccentric).....
1389C	24879	Feed Bar Hinge Pin Set Screw.....
164004	24879	Feed Bar Slide Block (back) (2).....
1628C	24879	Feed Bar Slide Block (back) Nut.....
17022	24879	Feed Bar Slide Block (back) Nut Washer..
164366	24879	Feed Bar Slide Block (front).....
164687	24879	Feed (back) Bar with 164010.....
164017	24879	Feed (back) Bar Connection.....
164008	24879	Feed (back) Bar Connection Bearing.....
164009	24879	Feed (back) Bar Connection Hinge Screw Stud.....
1671C	24879	Feed (back) Bar Connection Hinge Screw Stud Nut.....
164010	24879	Feed (back) Bar Connection Hinge Screw Stud Position Pin.....
164615	24886	Feed (back) Dog Section (left).....
164616	24886	Feed (back) Dog Section (right).....
1100AL	24886	Feed (back) Dog Section (right) Screw....
164617	24886	Feed (back) Dog complete, Nos. 1100AL, 164615 and 164616.....
1454F	24886	Feed (back) Dog Screw.....
164020	24879	Feed (back) Eccentric.....
		NOTE: Feed (back) Eccentric No. 164020 is furnished in 6 to 16, 18, 20, 22, 24, 28, 32 and 36 stitches to the inch.
164006	24879	Feed (front) Bar with 164010.....
164007	24879	Feed (front) Bar Connection.....
164018	24879	Feed (front) Bar Connection Bearing.....
164009	24879	Feed (front) Bar Connection Hinge Screw Stud.....
1671C	24879	Feed (front) Bar Connection Hinge Screw Stud Nut.....
164010	24879	Feed (front) Bar Connection Hinge Screw Stud Position Pin.....
164370	-----	Feed (back) and (front) Bars complete, Nos. 164006, 164007, 164008, 164017, 164018, 164366, 164687 and two each 1671C, 164004 and 164009.....
164618	24886	Feed (front) Dog.....
1454F	24886	Feed (front) Dog Screw.....
164020	24879	Feed (front) Eccentric.....
		NOTE: Feed (front) Eccentric No. 164020 is furnished in 6 to 16, 18, 20, 22, 24, 28, 32 and 36 stitches to the inch.
164520	24879	Feed Eccentric Cover.....
164399	24879	Feed Eccentric Cover Bracket with 164023
157C	24879	Feed Eccentric Cover Bracket Screw.....
629K	24879	Feed Eccentric Cover Hinge Screw.....
164401	24879	Feed Eccentric Cover Latch Spring.....
227J	24879	Feed Eccentric Cover Latch Spring Screw (2).....
164023	24879	Feed Eccentric Oil Wick.....
164521	24879	Feed Eccentric Cover complete, for use with eccentrics of 4 stitches and above, Nos. 629K, 164399, 164401, 164520 and two 227J.....

No.	Plate	Name
164372	24880	Feed Lifting and Knife (movable) Lever Eccentric.....
164455	24881	Finger Guard.....
164456	24881	Finger Guard Adaptor.....
1259AL	24884	Finger Guard Adaptor Screw.....
1423J	24881	Finger Guard Screw.....
164556	24882	Knife (movable) <i>Lever</i>
164027	24882	Knife (movable) Clamp.....
140050C	24882	Knife (movable) Clamp Screw.....
164028	24882	Knife (movable) Guard (lower).....
164458	24882	Knife (movable) Guard (upper).....
164029	24882	Knife (movable) Holder.....
198J	24882	Knife (movable) Holder Screw.....
164030	24882	Knife (movable) Holder Screw Bearing....
164714	24882	Knife (movable) Lever with 620AL.....
164715	-----	Knife (movable) Lever 164714 with 132583, 164035, 164136 and 164153.....
164032	24882	Knife (movable) Lever Bearing.....
447AL	24882	Knife (movable) Lever Bearing Set Screw (long).....
624AL	24882	Knife (movable) Lever Bearing Set Screw (short).....
164373	24884	Knife (movable) Lever Cover and Presser Bar (upright) Housing with 1259AL.....
50073J	24884	Knife (movable) Lever Cover and Presser Bar (upright) Housing Screw (2).....
164885	-----	Knife (movable) Lever Cover and Presser Bar (upright) Housing complete, Nos. 50060K, 164137, 164139, 164142, 164143, 164144, 164194, 164373 and 164884.....
164180	24881	Knife (movable) Lever Guide.....
164181	24881	Knife (movable) Lever Guide Holder with two 140239AL.....
164824	24881	Knife (movable) Lever Guide Holder 164181 with 197J, 164180, 164823 and 164827.....
140239AL	24881	Knife (movable) Lever Guide Holder Set Screw.....
164823	24881	Knife (movable) Lever Guide Holder Thread Tube.....
447AL	24881	Knife (movable) Lever Guide Holder Thread Tube Set Screw.....
197J	24881	Knife (movable) Lever Guide Screw.....
132583	24882	Knife (movable) Lever Hinge Pin with 132584.....
132584	24882	Knife (movable) Lever Hinge Pin Oil Wick
620AL	24882	Knife (movable) Lever Hinge Pin Set Screw.....
164034	24882	Knife (movable) Lever Hinge Stud.....
164035	-----	Knife (movable) Lever Hinge Stud 164034 with 164036 and 164269.....
164036	24882	Knife (movable) Lever Hinge Stud Oil Wick (long).....
164269	-----	Knife (movable) Lever Hinge Stud Oil Wick (short).....

No.	Plate	Name
447AL	24882	Knife (movable) Lever Hinge Stud Set Screw (back).....
1143AL	24882	Knife (movable) Lever Hinge Stud Set Screw (top).....
164728	24882	Knife (stationary) wide (2). <i>upper</i>
164744	24882	Knife (stationary) Clamping Gib.....
140788C	24882	Knife (stationary) Clamping Gib Screw....
3146	24882	Knife (stationary) Clamping Gib Screw Washer.....
164746	24882	Knife (stationary) Holder.....
164747	-----	Knife (stationary) Holder (adjustable) complete, Nos. 742F, 164745 and 164746
164748	24882	Knife (stationary) Holder (adjustable) with Gib complete, Nos. 3146, 140788C, 164744 and 164747.....
164590	24882	Knife (stationary) Holder Adjusting Stud ..
190E	24882	Knife (stationary) Holder Adjusting Stud Cap Screw.....
39541	24882	Knife (stationary) Holder Adjusting Stud Cap Screw Washer.....
164745	24882	Knife (stationary) Holder Body with two 50611C.....
50611C	24882	Knife (stationary) Holder Position Screw (2).....
742F	24882	Knife (stationary) Holder Screw.....
164042	24882	Knife (stationary) Holder Sleeve.....
140088E	24882	Knife (stationary) Holder Sleeve Screw ...
175032	24882	Knife (stationary) Holder Sleeve Screw Washer.....
164043	24882	Knife (stationary) Holder Spring.....
164525	24882	Knife (stationary) Holder Spring Stud....
164619	24883	Looper (left hand) <i>(Bolt)</i>
164046	24883	Looper (left hand) Carrier with 460AL, 50379F and 164202.....
164660	24883	Looper (left hand) Carrier Holder with 1083C, 140393AL and 140596AL.....
164661	-----	Looper (left hand) Carrier Holder 164660 with 1324C, 59456 and 164046.....
1083C	24883	Looper (left hand) Carrier Holder Clamp- ing Screw.....
140596AL	-----	Looper (left hand) Carrier Holder Set Screw (left).....
140393AL	24883	Looper (left hand) Carrier Holder Set Screw (right).....
1324C	24883	Looper (left hand) Carrier Screw.....
460AL	24883	Looper (left hand) Carrier Screw Set Screw.....
59456	24883	Looper (left hand) Carrier Screw Washer..
164048	24883	Looper (left hand) Driving Shaft.....
164049	24883	Looper (left hand) Driving Shaft Bushing (back).....
140394E	24883	Looper (left hand) Driving Shaft Bushing (back) Cap Screw.....
164293	24883	Looper (left hand) Driving Shaft Bushing (back) Cap Screw Washer.....

No.	Plate	Name
164737	24883	Looper (left hand) Driving Shaft Bushing (front).....
164051	24883	Looper (left hand) Driving Shaft Crank with 1083C.....
1083C	24883	Looper (left hand) Driving Shaft Crank Clamping Screw.....
164052	24880	Looper (left hand) Driving Shaft Crank Connection with two each 171AL and 140159AL.....
164215	-----	Looper (left hand) Driving Shaft Crank 164051 with 164052.....
171AL	24880	Looper (left hand) Driving Shaft Crank Connection Cap (lower) Screw (2).....
140159AL	24880	Looper (left hand) Driving Shaft Crank Connection Cap (upper) Screw (2).....
164067	24883	Looper (left hand) Driving Shaft Crank Key
1324C	24883	Looper (left hand) Driving Shaft Crank Key Screw.....
45057	24883	Looper (left hand) Driving Shaft Crank Key Screw Washer.....
164053	24883	Looper (left hand) Driving Shaft Crank Thrust Bearing.....
164739	24883	Looper (left hand) Driving Shaft Oil Ring (rubber).....
164740	24883	Looper (left hand) Driving Shaft Oil Ring Spacer.....
50379F	24883	Looper (left hand) Set Screw.....
164202	24883	Looper (left hand) Stop Pin.....
164054	24886	Looper (left hand) Thread Tube.....
853AL	24886	Looper (left hand) Thread Tube Set Screw..
164375	24883	Looper (right hand) <i>(Screw)</i>
164056	24883	Looper (right hand) Carrier with 50379AL..
164828	24883	Looper (right hand) Carrier Connection...
164829	-----	Looper (right hand) Carrier Connection Guide Bar Nos. 1700J, 50420AL, 164785, 164786 and 164828.....
164597	24883	Looper (right hand) Carrier Connection Guide Bar Bracket with two 462AL.....
914C	24883	Looper (right hand) Carrier Connection Guide Bar Bracket Screw (left).....
1057AL	24883	Looper (right hand) Carrier Connection Guide Bar Bracket Screw (right).....
462AL	24883	Looper (right hand) Carrier Connection Guide Bar Set Screw (2).....
164785	24883	Looper (right hand) Carrier Connection Guide Bar Oil Controlling Screw Seat (brass).....
50420AL	24883	Looper (right hand) Carrier Connection Guide Bar Oil Plug Screw.....
1700J	24883	Looper (right hand) Carrier Connection Guide Bar Oil Plug Screw Nut.....
164786	24883	Looper (right hand) Carrier Connection Guide Bar Oil Wick.....
164061	24883	Looper (right hand) Carrier Connection Hinge Stud with 1019AL.....

No.	Plate	Name
1443J	24883	Looper (right hand) Carrier Connection Hinge Stud Cap Screw.....
164397	24883	Looper (right hand) Carrier Connection Hinge Stud Adjusting Pin.....
1019AL	----	Looper (right hand) Carrier Connection Hinge Stud Adjusting Pin Set Screw.....
132565	24883	Looper (right hand) Carrier Hinge Pin ...
50370AL	24883	Looper (right hand) Carrier Hinge Pin Set Screw.....
164062	24883	Looper (right hand) Driving Lever with 1083C and two 140596AL.....
164830	----	Looper (right hand) Driving Lever 164062 with 1443J, 1700J, 132565, 164056, 164061, 164068, 164397, 164597 and 164829.....
1083C	24883	Looper (right hand) Driving Lever Clamping Screw
140596AL	24883	Looper (right hand) Driving Lever Set Screw (2)
164063	24883	Looper (right hand) Driving Shaft.....
164049	24883	Looper (right hand) Driving Shaft Bushing (back)
140394E	24883	Looper (right hand) Driving Shaft Bushing (back) Cap Screw
164293	24883	Looper (right hand) Driving Shaft Bushing (back) Cap Screw Washer.....
164738	24883	Looper (right hand) Driving Shaft Bushing (front).....
164066	24883	Looper (right hand) Driving Shaft Crank with 1083C
164216	----	Looper (right hand) Driving Shaft Crank 164066 with 164052.....
1083C	24883	Looper (right hand) Driving Shaft Crank Clamping Screw.....
164052	24880	Looper (right hand) Driving Shaft Crank Connection with two each 171AL and 140159AL
171AL	24880	Looper (right hand) Driving Shaft Crank Connection Cap (lower) Screw (2).....
140159AL	24880	Looper (right hand) Driving Shaft Crank Connection Cap (upper) Screw (2).....
164067	24883	Looper (right hand) Driving Shaft Crank Key
1324C	24883	Looper (right hand) Driving Shaft Crank Key Screw.....
45057	24883	Looper (right hand) Driving Shaft Crank Key Screw Washer
164053	24883	Looper (right hand) Driving Shaft Crank Thrust Bearing
164739	24883	Looper (right hand) Driving Shaft Oil Ring (rubber).....
164740	24883	Looper (right hand) Driving Shaft Oil Ring (spacer)
164068	24883	Looper (right hand) Locking Screw Stud ..
1700J	24883	Looper (right hand) Locking Screw Stud Nut.....

No.	Plate	Name
164219	24883	Looper (right hand) Position Collar with 904AL.....
904AL	24883	Looper (right hand) Position Collar Set Screw.....
*164072	----	Machine Frame
*164526	----	Machine Frame complete, Nos. 140396E, 164072, 164077, 164528 and three 140395C
164074	24813	Machine Frame Bottom Cover
164075	24813	Machine Frame Bottom Cover Gasket.....
914C	24813	Machine Frame Bottom Cover Screw (13) ..
*164527	----	Machine Frame Bracket.....
*164528	----	Machine Frame Bracket 164527 with 164207 and two 187E.....
164207	24860	Machine Frame Bracket Key.....
187E	24860	Machine Frame Bracket Key Screw (2) ...
140396E	24860	Machine Frame Bracket Screw (large)....
164077	24860	Machine Frame Bracket Screw (large) Washer (fiber).....
164229	24860	Machine Frame Bracket Screw (large) Washer (felt)
140395C	24860	Machine Frame Bracket Screw (small) (3) ..
164515	24813	Machine Frame Cover (back).....
50571J	24813	Machine Frame Cover (back) Screw (long) (2).....
914J	24813	Machine Frame Cover (back) Screw (short)
164516	24813	Machine Frame Cover (back) 164515 with 1637K and 140228C
164081	24860	Machine Frame Oil Lead.....
140088E	24860	Machine Frame Oil Lead Screw.....
1698J	24860	Machine Frame Oil Lead Screw Nut
164082	24860	Machine Frame Oil Plug Bracket.....
140346AL	24860	Machine Frame Oil Plug Bracket Set Screw.....
164083	24860	Machine Frame Oil Screen
206J	24860	Machine Frame Oil Screen Screw (3).....
164608	24860	Machine Frame Oil Splash Guard (internal)
164605	24860	Machine Frame Oil Splash Guard (internal) Oil Pad.....
164606	24860	Machine Frame Oil Splash Guard (internal) Oil Pad Fastener
164609	24860	Machine Frame Oil Splash Guard (internal) complete, Nos. 164605, 164606 and 164608
164620	24884	Machine Frame Oil Splash Guard (top)....
51023W	24884	Machine Frame Oil Splash Guard (top) Screw (2).....
164722	24860	Machine Frame Oil Tube with 164602.....
447AL	24860	Machine Frame Oil Tube Set Screw.....
164602	24860	Machine Frame Oil Tube Wick.....
164376	24880	Machine Frame Rotary Shaft.....
164377	----	Machine Frame Rotary Shaft 164376 with 164097, 164215, 164216, 164217 and two each 164093 and 164232
139026	24880	Machine Frame Rotary Shaft Ball Bearing
164092	24880	Machine Frame Rotary Shaft Ball Bearing Housing

No.	Plate	Name
51369C	24880	Machine Frame Rotary Shaft Ball Bearing Housing Screw (3).....
164093	24880	Machine Frame Rotary Shaft Ball Sleeve (two pieces) (2)
164232	24880	Machine Frame Rotary Shaft Ball Sleeve Guide (2)
164600	24880	Machine Frame Rotary Shaft Bushing (front).....
1036AL	24880	Machine Frame Rotary Shaft Bushing (front) Set Screw.....
164095	24880	Machine Frame Rotary Shaft Bushing (intermediate).....
51332C	24880	Machine Frame Rotary Shaft Bushing (intermediate) Set Screw.....
164096	24880	Machine Frame Rotary Shaft Counter-balance with 1036AL.....
1036AL	24880	Machine Frame Rotary Shaft Counter-balance Set Screw.....
164097	24880	Machine Frame Rotary Shaft Key.....
51649C	24880	Machine Frame Rotary Shaft Nut.....
131056	24880	Machine Frame Rotary Shaft Nut Washer ..
164098	24880	Machine Frame Rotary Shaft Oil and Ball Bearing Grease Retainer.....
164099	24880	Machine Frame Rotary Shaft Screw Stud..
164100	24880	Machine Frame Rotary Shaft Thrust Bearing.....
164101	24885	Machine Frame Top Cover.....
164214	-----	Machine Frame Top Cover 164101 with 330J, 164103 and two 164418.....
164102	24885	Machine Frame Top Cover Gasket
164103	24885	Machine Frame Top Cover Oil Lead.....
330J	24885	Machine Frame Top Cover Oil Lead Screw
51369J	24885	Machine Frame Top Cover Screw (3).....
164231	24880	Machine Pulley (3/8 in. "V" belt) with two 448AL
164071	24880	Machine Pulley Cap
140416X	24880	Machine Pulley Cap Screw
448AL	24880	Machine Pulley Set Screw (2).....
164621	24884	Needle Clamp
51768C	24884	Needle Clamping Nut
175032C	24884	Needle Clamping Nut Washer.....
164622	24884	Needle Driving Shaft with 164625.....
164684	-----	Needle Driving Shaft 164622 with 51768C, 164621, 164685 and 175032C
164111	24884	Needle Driving Shaft Bushing.....
164112	24884	Needle Driving Shaft Bushing Cap.....
164113	24884	Needle Driving Shaft Bushing Oil Lead.....
452AL	24884	Needle Driving Shaft Bushing Oil Lead Hole Plug Screw
164114	24884	Needle Driving Shaft Crank with 1083C and two 140596AL.....
164115	24884	Needle Driving Shaft Crank Ball.....
1083C	24884	Needle Driving Shaft Crank Clamping Screw.....
164217	24880	Needle Driving Shaft Crank Connection with 164115 and two each 157AL and 171AL.....

No.	Plate	Name
157AL	24880	Needle Driving Shaft Crank Connection Cap (lower) Screw (2).....
171AL	24880	Needle Driving Shaft Crank Connection Cap (upper) Screw (2).....
140596AL	24884	Needle Driving Shaft Crank Set Screw (2).
164685	24884	Needle Holder..... <i>2 Screws w/ hole</i>
164625	24884	Needle Stop Pin.....
164119	24880	Oil Agitator.....
164120	24860	Oil Cooler with two 164125.....
164121	24860	Oil Cooler Cover
164123	24860	Oil Cooler Cover 164121 with 164135.....
164122	24860	Oil Cooler Cover Gasket.....
145J	24860	Oil Cooler Cover Screw
164124	24860	Oil Cooler Gasket.....
164125	24860	Oil Cooler Oil Pipe (outlet, left).....
164125	24860	Oil Cooler Oil Pipe (outlet, right).....
164126	24860	Oil Cooler Oil Tube with 138269 and 164128
164736	-----	Oil Cooler Oil Tube 164126 with 51630 and 164127.....
164127	24860	Oil Cooler Oil Tube Coupling.....
51630	24860	Oil Cooler Oil Tube Lock Nut
138269	24860	Oil Cooler Oil Tube Sleeve.....
164128	24860	Oil Cooler Oil Tube Wick.....
51139J	24860	Oil Cooler Screw (long) (2).....
1324J	24860	Oil Cooler Screw (short).....
164135	24860	Oil Cup for filling machine.....
164607	24882	Oil Deflector.....
164131	24860	Oil Sight Gauge Background Disc
164132	24860	Oil Sight Gauge Background Disc Gasket ..
164133	24860	Oil Sight Gauge Window.....
164132	24860	Oil Sight Gauge Window Gasket.....
164134	24860	Oil Sight Gauge Window Retainer
164132	24860	Oil Sight Gauge Window Retainer Gasket ..
1485J	24860	Oil Sight Gauge Window Retainer Screw (2).....
164136	24882	Presser Bar Bracket.....
164137	24884	Presser Bar Lifting Bracket with 462AL, 624AL and 51846.....
51846	24884	Presser Bar Lifting Bracket Roller and Stud.....
624AL	24884	Presser Bar Lifting Bracket Set Screw (long)
462AL	24884	Presser Bar Lifting Bracket Set Screw (short).....
164884	24884	Presser Bar Lifting Lever.....
164139	24884	Presser Bar Lifting Lever Spring
140228C	24813	Presser Bar Lifting Lever Stop Screw ..
1637K	24813	Presser Bar Lifting Lever Stop Screw Nut
164640	24881	Presser Bar (swing-out)
164141	24881	Presser Bar (swing-out) Lifting Screw Stud.....
1700J	24881	Presser Bar (swing-out) Lifting Screw Stud Nut
164142	24884	Presser Bar (swing-out) Opening Lever..

No.	Plate	Name
50060K	24884	Presser Bar (swing-out) Opening Lever Hinge Screw.....
140510C	24881	Presser Bar (swing-out) Pivot Screw
164351	24881	Presser Bar (swing-out) Pivot Screw Lock Washer
51362AL	24881	Presser Bar (swing-out) Pivot Screw Lock Washer Screw
164143	24884	Presser Bar (upright).....
164144	24884	Presser Bar (upright) Spring.....
164626	24886	Presser Foot Body.....
164146	24886	Presser Foot Chaining-off Finger.....
164147	24886	Presser Foot Clamping Plate.....
164360	24886	Presser Foot Guide
50169J	24886	Presser Foot Guide Screw
164627	24886	Presser Foot with Chain Cutter complete, Nos. 50169J, 50225J, 164146, 164147, 164360 and 164626
50225J	24886	Presser Foot Screw
164194	24884	Pressure Regulating Thumb Screw
2102	24885	Tension (heavy) Disc (6).....
164155	24885	Tension (heavy) Regulating Thumb Nut (3)
50133C	24885	Tension (heavy) Screw Stud (3)
1700J	24885	Tension (heavy) Screws Stud Nut (2)
164156	-----	Tension (heavy) Screw Stud 50133C and 164155 (3).....
164161	24885	Tension (heavy) Spring (3)
59537	24885	Tension (heavy) Spring Bushing (3)
164158	24885	Tension (heavy) Spring Cover (3).....
164162	24885	Tension (heavy) complete, Nos. 59537, 164156, 164158, 164161 and two 2102 (3).
2102	24885	Tension (light) Disc (2).....
164155	24885	Tension (light) Regulating Thumb Nut
50133C	24885	Tension (light) Screw Stud
164156	-----	Tension (light) Screw Stud 50133C with 164155.....
164157	24885	Tension (light) Spring
59537	24885	Tension (light) Spring Bushing.....
164158	24885	Tension (light) Spring Cover
164160	24885	Tension (light) complete, Nos. 59537, 164156, 164157, 164158 and two 2102....
164285	24885	Tension (looper thread) Thread Guide (left)
164286	24885	Tension (looper thread) Thread Guide (right)
164418	24885	Tension Thread Eyelet (2)
164628	24885	Tension Thread Guide (double)
1353AL	24885	Tension Thread Guide Screw
164629	24885	Tension Thread Guide Spacing Block
164630	24885	Tension (double) complete, Nos. 164628 and two each 1700J and 164162.....
164825	24881	Thread Eyelet (needle thread)
164826	24881	Thread Eyelet (needle thread) Holder
164827	-----	Thread Eyelet (needle thread) Holder 164826 with 1607J and 164825.....
1607J	24881	Thread Eyelet (needle thread) Nut
140239AL	24881	Thread Eyelet (needle thread) Set Screw..

No.	Plate	Name
164091	24883	Thread (looper, right hand) Stripper and Take-up with 164555.....
164163	24761	Thread (looper, right hand) Stripper and Take-up Eyelet (adjustable)
1443J	24761	Thread (looper, right hand) Stripper and Take-up Eyelet (adjustable) Screw.....
164555	-----	Thread (looper, right hand) Stripper and Take-up Guide Wire.....
187E	24883	Thread (looper, right hand) Stripper and Take-up Screw.....
17022	24883	Thread (looper, right hand) Stripper and Take-up Screw Washer
164164	24761	Thread (looper, right hand) Thread Eyelet (movable).....
1423J	24761	Thread (looper, right hand) Thread Eyelet Screw.....
164165	24761	Thread (looper, right hand) Thread Eyelet (stationary)
1607J	24761	Thread (looper, right hand) Thread Eyelet (stationary) Nut.....
164166	24761	Thread (looper, right hand) Tube.....
624AL	24761	Thread (looper, right hand) Tube Set Screw
164167	24761	Thread (looper) Plate with 624AL.....
164168	24761	Thread (looper) Plate Cover
164206	-----	Thread (looper) Plate Cover 164168 with 164169 and 164170.....
164169	24761	Thread (looper) Plate Cover Hinge.....
164170	24761	Thread (looper) Plate Cover Hinge Pin...
164171	24761	Thread (looper) Plate Cover Spring (2)...
332J	24761	Thread (looper) Plate Cover Spring Screw (2)
896AL	24761	Thread (looper) Plate Screw (2)
164173	24761	Thread (looper) Plate Thread Bushing...
50318W	24761	Thread (looper) Plate Thread Bushing Screw.....
164174	-----	Thread (looper) Plate complete, Nos. 1423J, 1443J, 1607J, 50318W, 164163, 164164, 164165, 164166, 164167, 164173, 164206 and two each 332J and 164171....
164175	24883	Thread (looper) Take-up.....
164176	24883	Thread (looper) Take-up Plate
190E	24883	Thread (looper) Take-up Screw (lower) ..
1443J	24883	Thread (looper) Take-up Screw (upper) ..
164151	24882	Thread (needle) Controller.....
164153	24882	Thread (needle) Controller Lever.....
1443J	24882	Thread (needle) Controller Screw (2)
164632	24886	Throat Plate.....
164591	24886	Throat Plate Guide with 853AL
1454E	24886	Throat Plate Guide Screw
1094F	24886	Throat Plate Screw (2)

From the library of Diamond Needle Corp.

FITTINGS

SET OF FITTINGS COMPLETE NO. 164647
For .109 in. Space Between Needles.

NOTE: Set of Fittings No. 164647 is regular to machine, unless otherwise stated on machine order.

No.	Plate	Name
164615	24887	Feed (back) Dog Section (left).....
164616	24887	Feed (back) Dog Section (right)
1100AL	24887	Feed (back) Dog Section (right) Screw
164617	24887	Feed (back) Dog complete, Nos. 1100AL, 164615 and 164616
164618	24887	Feed (front) Dog
164556	24887	Knife (movable)
151X7	24887	Needle (2)
164621	24887	Needle Clamp
51768C	24887	Needle Clamping Nut
175032C	24887	Needle Clamping Nut Washer
164622	24887	Needle Driving Shaft with 164625
164684	-----	Needle Driving Shaft 164622 with 51768C, 164621, 164685 and 175032C
164685	24887	Needle Holder
164625	24887	Needle Stop Pin
164640	24887	Presser Bar (swing-out)
164626	24887	Presser Foot Body
164146	24887	Presser Foot Chaining-off Finger
164147	24887	Presser Foot Clamping Plate
164360	24887	Presser Foot Guide
50169J	24887	Presser Foot Guide Screw
50225J	24887	Presser Foot Screw
164627	24887	Presser Foot complete, Nos. 50169J, 50225J, 164146, 164147, 164360 and 164626
164175	24887	Thread (looper, left hand) Take-up
164091	24887	Thread (looper, right hand) Stripper and Take-up
164151	24887	Thread (needle) Controller
164632	24887	Throat Plate
164591	24887	Throat Plate Guide
164647	24887	Set of Fittings complete, Nos. 164091, 164151, 164175, 164556, 164591, 164617, 164618, 164627, 164632, 164640, 164684 and two Needles (151X7)

SET OF FITTINGS COMPLETE NO. 164644
For 1/16 in. Space Between Needles.

No.	Plate	Name
164633	24888	Feed (back) Dog Section (left).....
164634	24888	Feed (back) Dog Section (right)
1100AL	24888	Feed (back) Dog Section (right) Screw
164635	24888	Feed (back) Dog complete, Nos. 1100AL, 164633 and 164634
164636	24888	Feed (front) Dog
151X9	-----	Needles (2) No. 11
164637	24888	Needle Clamp
51720C	24888	Needle Clamping Nut
164622	24888	Needle Driving Shaft with 164625
164638	-----	Needle Driving Shaft 164622 with 51720C, 164637 and 164639
164639	24888	Needle Holder
164625	24888	Needle Stop Pin
164626	24888	Presser Foot Body
164641	24888	Presser Foot Chaining-off Finger
164147	24888	Presser Foot Clamping Plate
164360	24888	Presser Foot Guide
50169J	24888	Presser Foot Guide Screw
50225J	24888	Presser Foot Screw
164642	24888	Presser Foot complete, Nos. 50169J, 50225J, 164147, 164360, 164626 and 164641
164682	24888	Throat Plate (1/8 in. bight)
164644	24888	Set of Fittings complete, Nos. 164635, 164636, 164638, 164642, 164682 and two needles (151X9 No. 11)
NOTE:		When using Set of Fittings complete No. 164644, the following parts which are not included in this Set of Fittings, are necessary, if machine has previously been fitted other than regular (see Set of Fittings No. 164647)
164556	24888	Knife (movable)
164640	24888	Presser Bar (Swing-out)
164175	24888	Thread (looper, left hand) Take-up
164091	24888	Thread (looper, right hand) Stripper and Take-up
164151	24888	Thread (needle) Controller
164591	24888	Throat Plate Guide

1/16 = .0625

From Illinois State University Library

SET OF FITTINGS COMPLETE NO. 164677
For Intermittent Gathering
Knee or Manual Control For Ninon, Organdy, Taffeta
and Cotton Materials.

No.	Plate	Name
164671	24889	Feed (back) Dog Section (left)
164672	24889	Feed (back) Dog Section (right)
1100AL	24889	Feed (back) Dog Section (right) Screw
164673	24889	Feed (back) Dog complete, Nos. 1100AL, 164671 and 164672
164674	24889	Feed (front) Dog
164566	24889	Gathering Plate (swing-out, pivoted)
164569	-----	Gathering Plate (swing-out, pivoted) complete, Nos. 164566, 164567 and 164568
164649	24889	Gathering Plate (swing-out, pivoted) Arm
1425J	24889	Gathering Plate (swing-out, pivoted) Arm Hinge Screw
42436	24889	Gathering Plate (swing-out, pivoted) Arm Hinge Screw Washer (3)
164573	24889	Gathering Plate (swing-out, pivoted) Arm Holder
164582	-----	Gathering Plate (swing-out, pivoted) Arm Holder (adjustable) complete, Nos. 164573, 164581 and two 190J,
50267R	24889	Gathering Plate (swing-out, pivoted) Arm Holder Screw (2)
164581	24889	Gathering Plate (swing-out, pivoted) Arm Seat
190J	24889	Gathering Plate (swing-out, pivoted) Arm Seat Screw (2)
164567	24889	Gathering Plate (swing-out, pivoted) Holder
164570	24889	Gathering Plate (swing-out, pivoted) Holder Bracket
50004J	24889	Gathering Plate (swing-out, pivoted) Holder Bracket Screw (2)
1550J	24889	Gathering Plate (swing-out, pivoted) Holder Bracket Screw Nut (2)
934B	24889	Gathering Plate (swing-out, pivoted) Holder Screw (2)
164568	24889	Gathering Plate (swing-out, pivoted) Pin
164576	24889	Gathering Plate (swing-out, pivoted) Pull
1143AL	24889	Gathering Plate (swing-out, pivoted) Stop Screw
1700C	24889	Gathering Plate (swing-out, pivoted) Stop Screw Nut
164650	-----	Gathering Plate (swing-out, pivoted) with Arm and Holder complete, Nos. 1143AL, 1425J, 1700C, 164569, 164570, 164576, 164582, 164649, two each 934B, 1550J, 50004J and three 42436

No.	Plate	Name
164655	24889	Gathering Plate (swing-out, solid)
164656	24889	Gathering Plate (swing-out, solid) with Arm and Holder complete, Nos. 1143AL, 1425J, 1700C, 164576, 164582, 164649, 164655, two each 1550J, 50004J and three 42436
		NOTE: No. 164656 will be furnished as regular with this Set of Fittings, unless otherwise specified.
164651	24889	Gathering Plate Presser Lever
140210C	24889	Gathering Plate Presser Lever Hinge Screw
1521X	24889	Gathering Plate Presser Lever Hinge Screw Nut
1377C	24889	Gathering Plate Presser Lever Screw Stud (eccentric)
1698X	24889	Gathering Plate Presser Lever Screw Stud (eccentric) Nut
24210	24889	Gathering Plate Presser Lever Screw Stud (eccentric) Nut Washer
164652	24889	Gathering Plate Pressure Bracket
164234	24889	Gathering Plate Pressure Bracket Adjusting Slide (cylindrical)
140657K	24889	Gathering Plate Pressure Bracket Adjusting Slide Screw
140457C	24889	Gathering Plate Pressure Bracket Adjusting Slide Screw Locking Screw
164653	24889	Gathering Plate Pressure Bracket Pressure Spring
51939	24889	Gathering Plate Pressure Bracket Roller
51940	-----	Gathering Plate Pressure Bracket Roller complete, Nos. 51939 with 140658F
140658F	24889	Gathering Plate Pressure Bracket Roller Screw Stud
1700J	24889	Gathering Plate Pressure Bracket Roller Screw Stud Nut
164578	24889	Gathering Plate Pressure Bracket Support
164654	24889	Gathering Plate Pressure Bracket and Support complete, Nos. 1377C, 1521X, 1698X, 1700J, 24210, 51940, 140210C, 140457C, 140657K, 164234, 164578, 164651, 164652 and 164653
164550	24889	Knife (movable)
164819	24889	Presser Bar (swing-out)
164675	24889	Presser Foot
164564	24889	Presser Foot Cord Guide (spring)
240J	24889	Presser Foot Cord Guide Screw
164676	24889	Presser Foot complete, Nos. 240J, 164564 and 164675
140180J	24889	Presser Foot Screw (2)
164580	24889	Tension Extension Plate (2)
140596AL	24889	Tension Extension Plate Screw (2)
1700J	24889	Tension Screw Stud Nut (2)

No.	Plate	Name
164677	24889	Set of Fittings complete, Nos. 164550, 164650 or 164656, 164654, 164673, 164674, 164676, 164819 and two each 1700J, 50267R, 140180J, 140596AL and 164580.
NOTE: When using Set of Fittings complete No. 164677, the following parts which are not included in this Set of Fittings, are necessary, if machine has previously been fitted other than regular (see Set of Fittings No. 164647)		
164375	24889	Looper (right hand).
164175	24889	Thread (looper, left hand) Take-up.
164091	24889	Thread (looper, right hand) Take-up.
164151	24889	Thread (needle) Controller.
164632	24889	Throat Plate.
164591	24889	Throat Plate Guide.
NOTE: Feed Eccentric (front) No. 164020 (No. 14 Cam) and Feed Eccentric (back) No. 164020 (No. 4 Cam) Ratio approximately 3 to 1, depending on material being stitched, will be regularly furnished on Machine with this Set of Fittings unless otherwise specified on order.		

ACCESSORIES

No.	Plate	Name
164203	24890	Feed Eccentric Extractor (Not regularly furnished with machine).
164883	24890	Gauge (Not regularly furnished with machine).
160725	24890	Oil Container.
160727	24890	Oil Container, Nos. 160725 and 160726.
160726	24890	Oil Container Cap.
160728	24890	Oil Container Spout, for use when filling Oil Reservoir.
164198	24890	Presser Bar Lifting Chain Spring (under table).
26026	24890	Screw Driver.
164196	24890	Threader (6).
164204	24890	Tweezers.
164197	24890	Wrench (socket).
164831	24890	Wrench for 1700.
8908	24890	Wrench (flat).

BELT GUARD (Adjustable)

No.	Plate	Name
164183	24866	Belt Guard.
164199	24866	Belt Guard Bracket (back).
164200	24866	Belt Guard Bracket (front).
51326J	24866	Belt Guard Screw (2).
164201	24866	Belt Guard (adjustable) complete, Nos. 164183, 164199, 164200 and two each 51326J and wood screws 3/4 in. No. 7 F.H.

CHIP CHUTE

No.	Plate	Name
168198	24866	Chip Chute with four wood screws 3/8 in. No. 6 R.H. blacked.

FOOT LIFTER PARTS

No.	Plate	Name
6439	24866	Chain, 36 in. to 45 in., with 56864 and 56865.
NOTE: When ordering No. 6439, give length required		
4879	24866	Chain Connecting Link.
56864	24866	Chain Hook (large).
56865	24866	Chain Hook (small).
4881	24866	Treadle.
4882	24866	Treadle Shaft.
4883	-----	Treadle Spring.
4884	24866	Treadle Stand.
4885	24866	Treadle complete, Nos. 4879, 4881, 4882, 4883, 4884 and two wood screws 1 in. No. 16 F.H.

MACHINE BASE

No.	Plate	Name
164184	24866	Machine Base and two each wood screws 3/4 in. No. 8 R.H. and 1-1/4 in. No. 6 F.H.
164188	24866	Machine Cushion (large) (2).
164189	24866	Machine Cushion (small) (2).
164190	24866	Machine Pad (felt).
140418E	24880	Machine Screw Stud (back).
657E	24880	Machine Screw Stud (front).

THREAD UNWINDER NO. 151163
FOR FOUR SPOOLS

No.	Plate	Name
228692	24867	Spool Pin (3).....
228764	24867	Spool Pin.....
201528X	-----	Spool Pin Nut (3).....
395243	-----	Spool Pin Washer (3).....
151023	24867	Spool Rest with 858AL and three each 201528X, 228692 and 395243(three spools)
228765	24867	Spool Rest with 201254C (one spool).....
150203	24867	Spool Rest Cushion (felt) (4).....
858AL	24867	Spool Rest Hub Set Screw.....
151024	24867	Spool Rest Rod.....
1122C	24867	Spool Rest Rod Set Screw (2).....
201254C	24867	Spool Rest Set Screw.....
151025	24867	Spool Rest Stand with two 1122C and three wood screws 1 in. No. 12 F.H.....
151026	24867	Thread Guide (lower).....
50311C	24867	Thread Guide (lower) Holder Set Screw...
151027	24867	Thread Guide (lower) Support with 50311C
151028	24867	Thread Guide (upper, hollow) (2).....
151162	24867	Thread Guide (upper, solid).....
151029	24867	Thread Guide (upper) Holder with four 453AL.....
453AL	24867	Thread Guide Set Screw (3).....
151030	24867	Thread Guide Rod.....
453AL	24867	Thread Guide Rod Set Screw.....
151163	24867	Thread Unwinder complete, Nos. 151023, 151024, 151025, 151026, 151027, 151029, 151030, 151162, 228764, 228765, two 151028 and four 150203.....

NUMERICAL LIST OF PARTS

No.	Plate	Name
145J	24860	Oil Cooler Cover Screw.....
157C	24879	Feed Eccentric Cover Bracket Screw.....
157AL	24880	Needle Driving Shaft Crank Connection Cap (lower) Screw for 164217.....
171AL	24880	Looper (left hand) Driving Shaft Crank Connection Cap (lower) Screw for 164052.....
171AL	24880	Looper (right hand) Driving Shaft Crank Connection Cap (lower) Screw for 164052.....
171AL	24880	Needle Driving Shaft Crank Connection Cap (upper) Screw for 164217.....
187E	24860	Machine Frame Bracket Key Screw for 164528.....
187E	24883	Thread (looper, right hand) Stripper and Take-up.....
190J	24889	Gathering Plate (swing-out, pivoted) Arm Seat Screw for 164582.....
190E	24882	Knife (stationary) Holder Adjusting Stud Cap Screw.....
190E	24883	Thread (looper) Take-up Screw (lower) ..
197J	24881	Knife (movable) Lever Guide Screw for 164824.....
198J	24882	Knife (movable) Holder Screw.....
206J	24860	Machine Frame Oil Screen Screw.....
227J	24879	Feed Eccentric Cover Latch Spring Screw for 164521.....
240J	24889	Presser Foot Cord Guide Screw for 164676.....
330J	24885	Machine Frame Top Cover Oil Lead Screw for 164214.....
332J	24761	Thread (looper) Plate Cover Spring Screw for 164174.....
447AL	24882	Knife (movable) Lever Bearing Set Screw (long).....
447AL	24881	Knife (movable) Lever Guide Holder Thread Tube Set Screw.....
447AL	24882	Knife (movable) Lever Hinge Stud Set Screw (back).....
447AL	24860	Machine Frame Oil Tube Set Screw.....
448AL	24880	Machine Pulley Set Screw for 164231.....
452AL	24884	Needle Driving Shaft Bushing Oil Lead Hole Plug Screw.....
453AL	24867	Thread Unwinder Thread Guide Set Screw for 151029.....
453AL	24867	Thread Unwinder Thread Guide Rod Set Screw for 151029.....
460AL	24883	Looper (left hand) Carrier Screw Set Screw for 164046.....
462AL	24883	Looper (right hand) Carrier Connection Guide Bar Set Screw for 164597.....

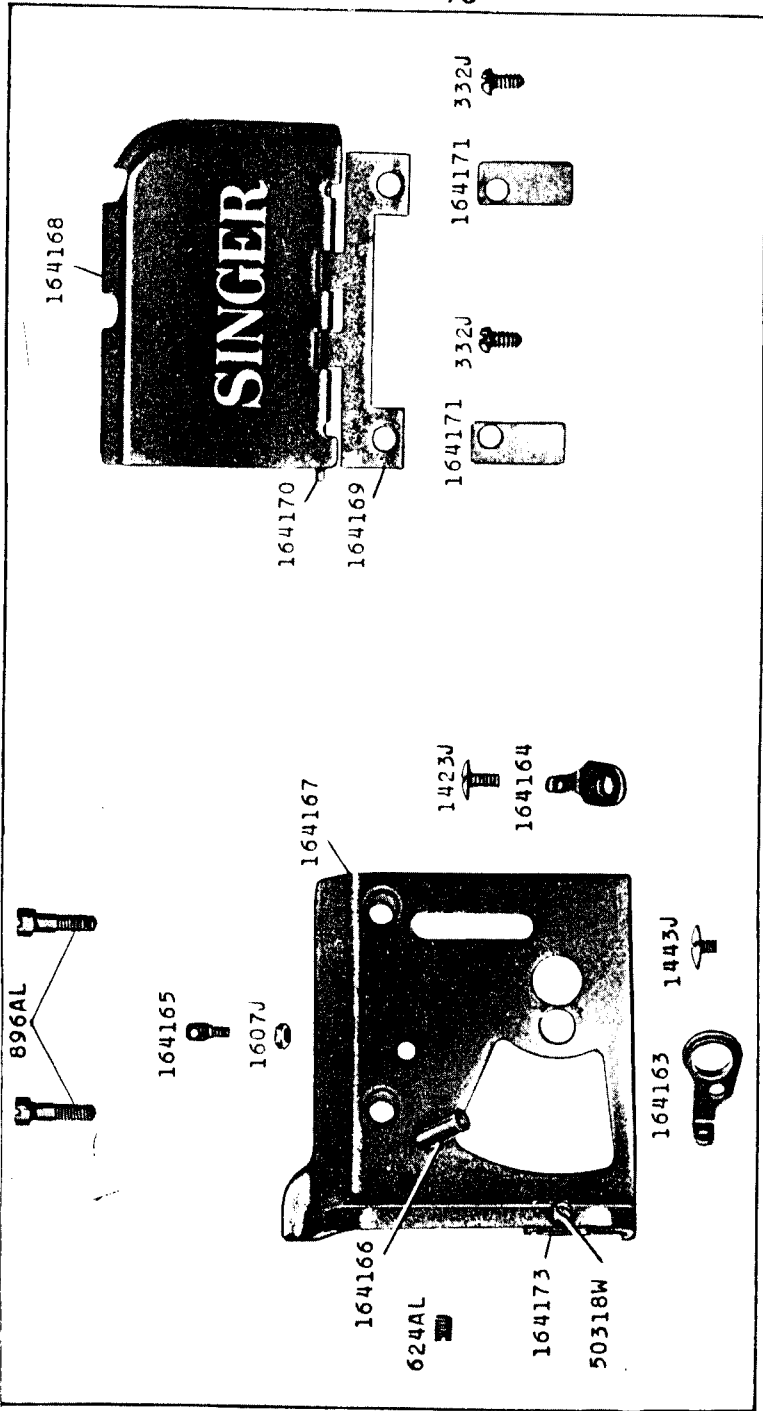

24866 - 1/4

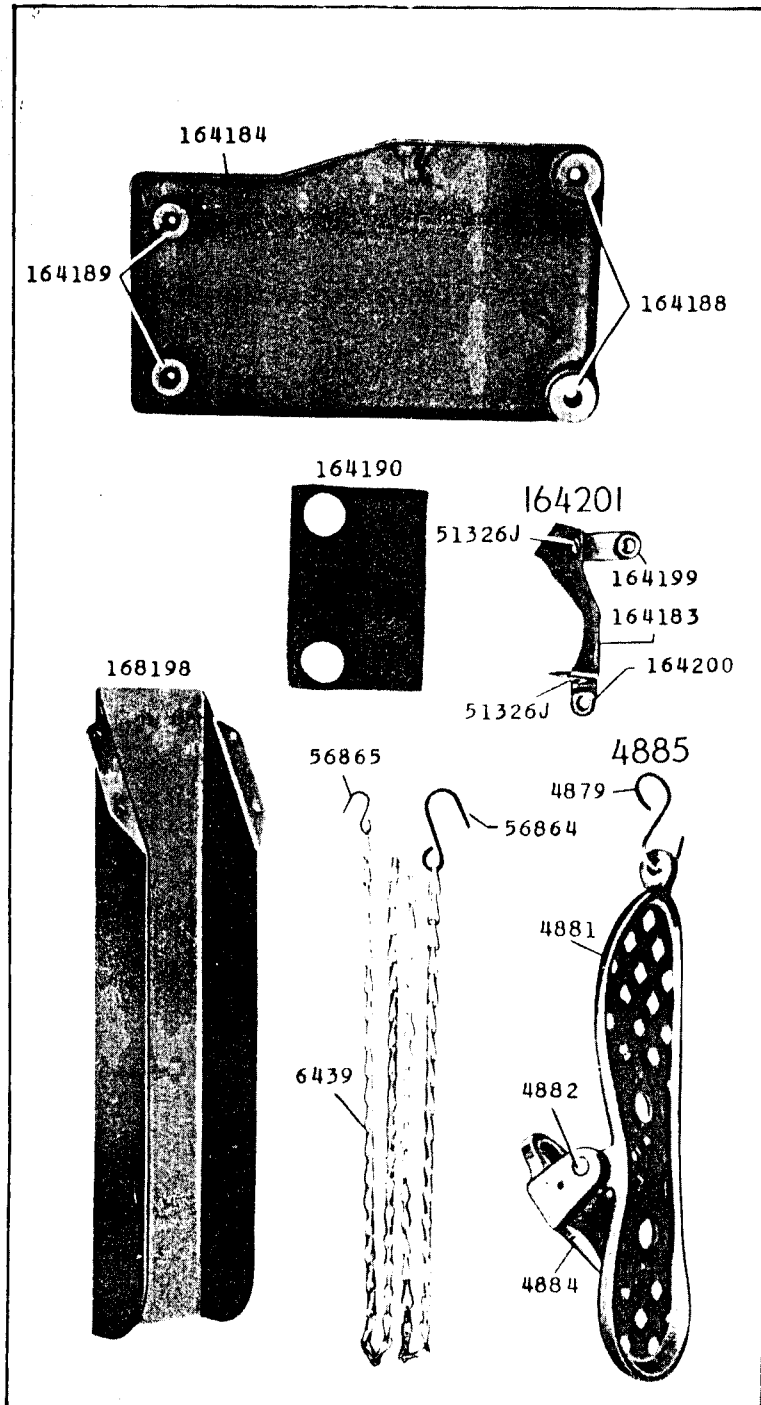

24867 - 1/6

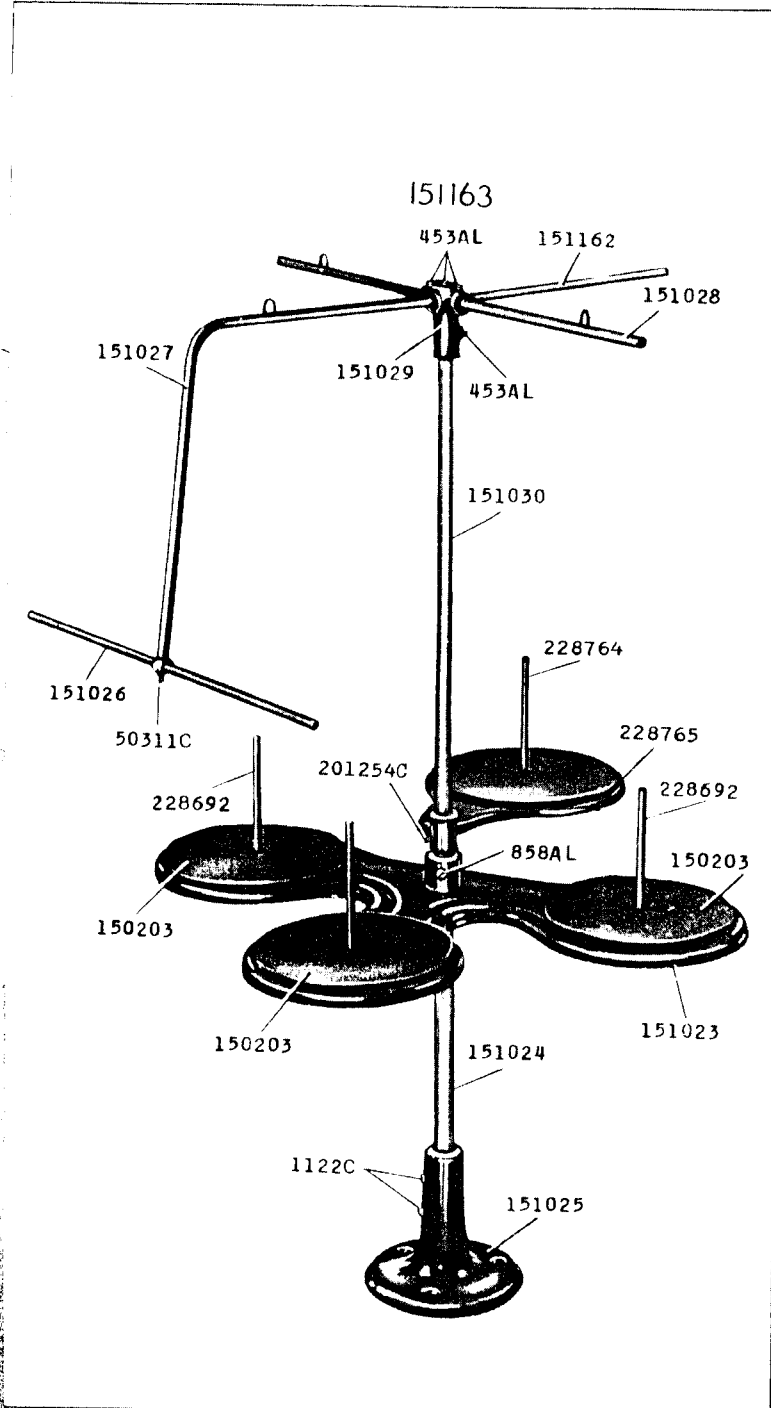

From the library of: Diamond Needle Corp

24878 1/2

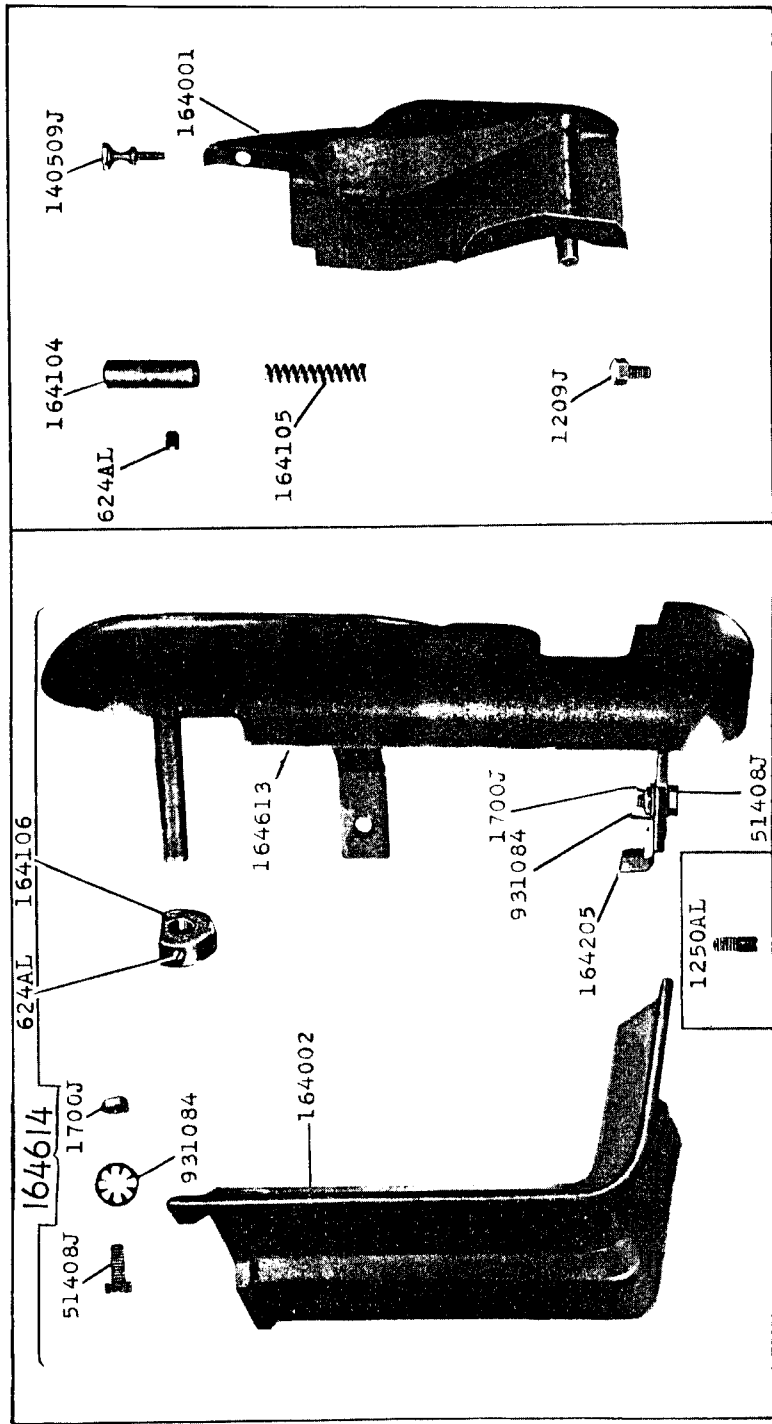

24879 1/2

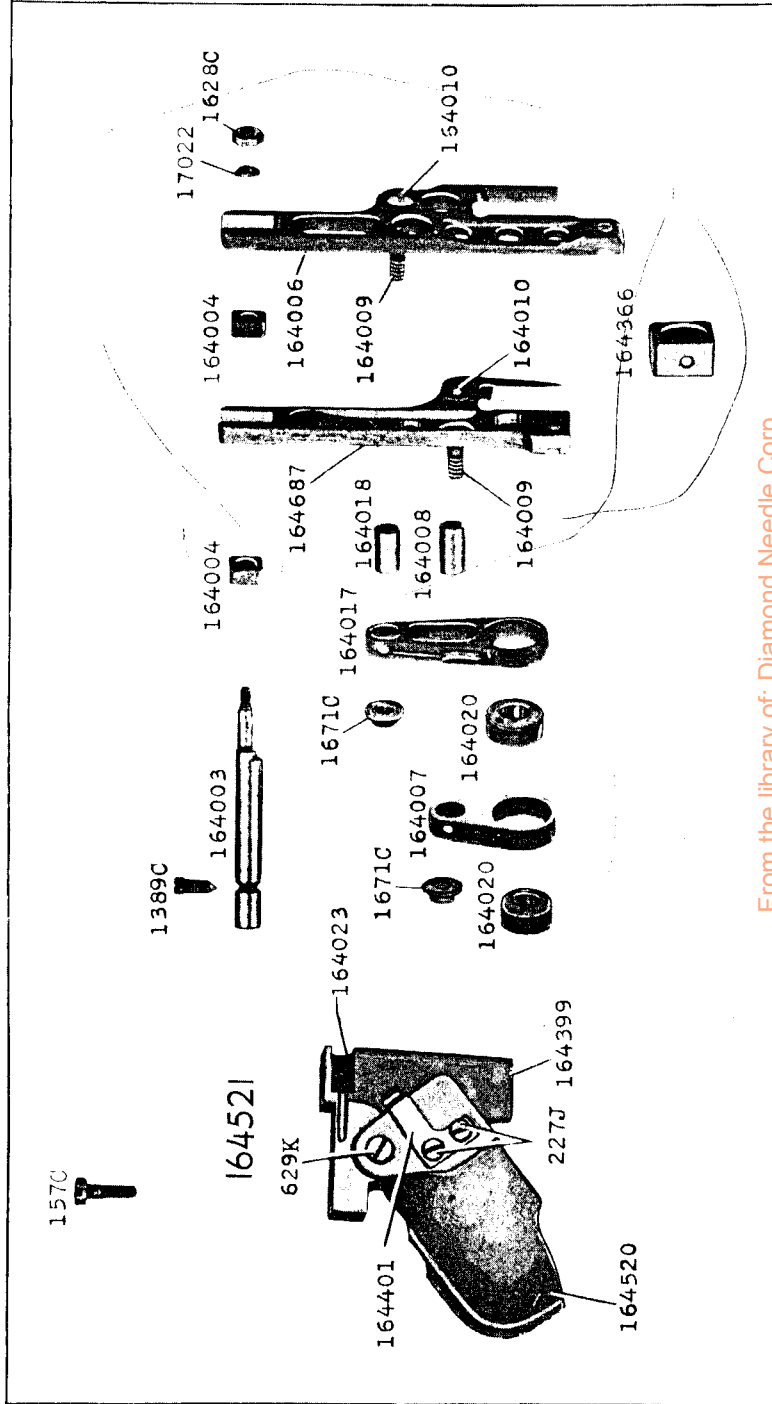

24825

24882 1/2

1653
TAS

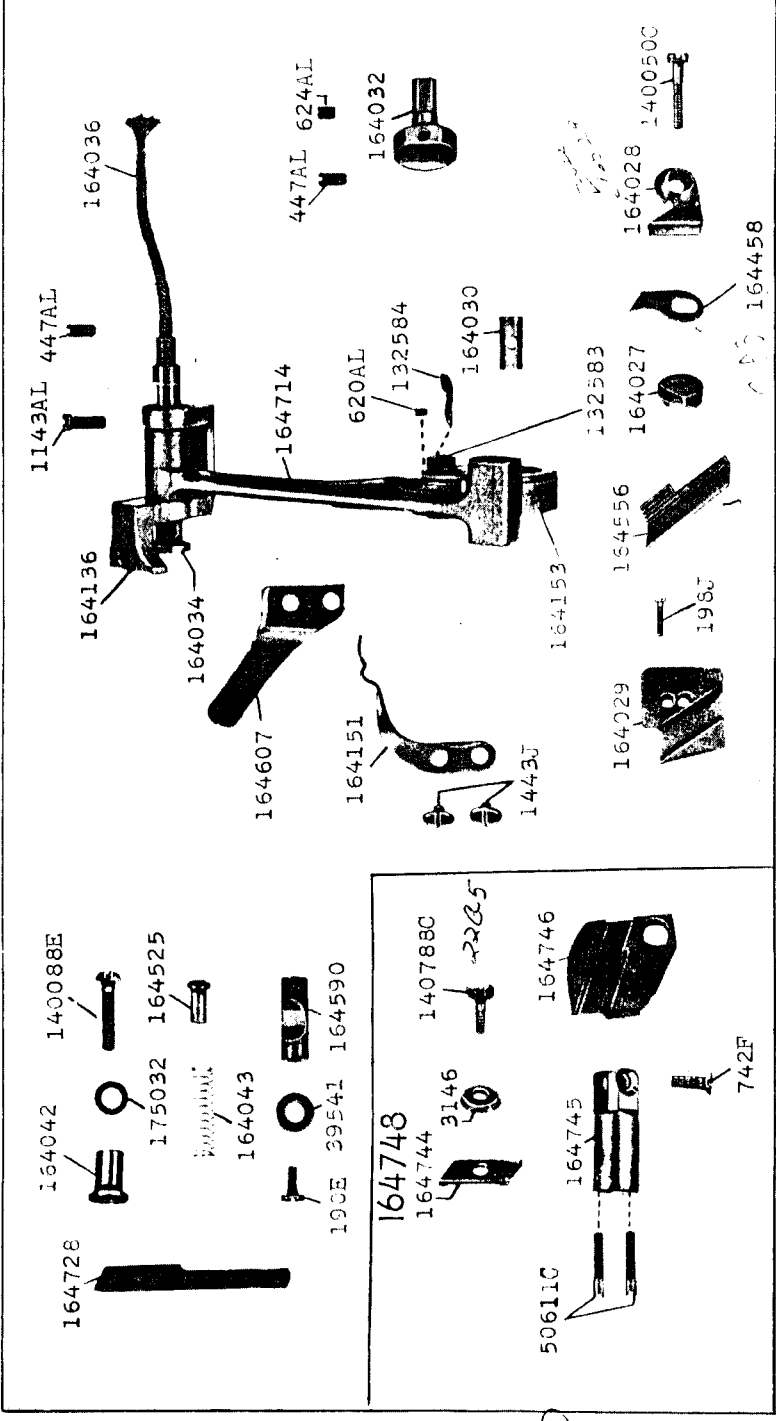

24883 1/2

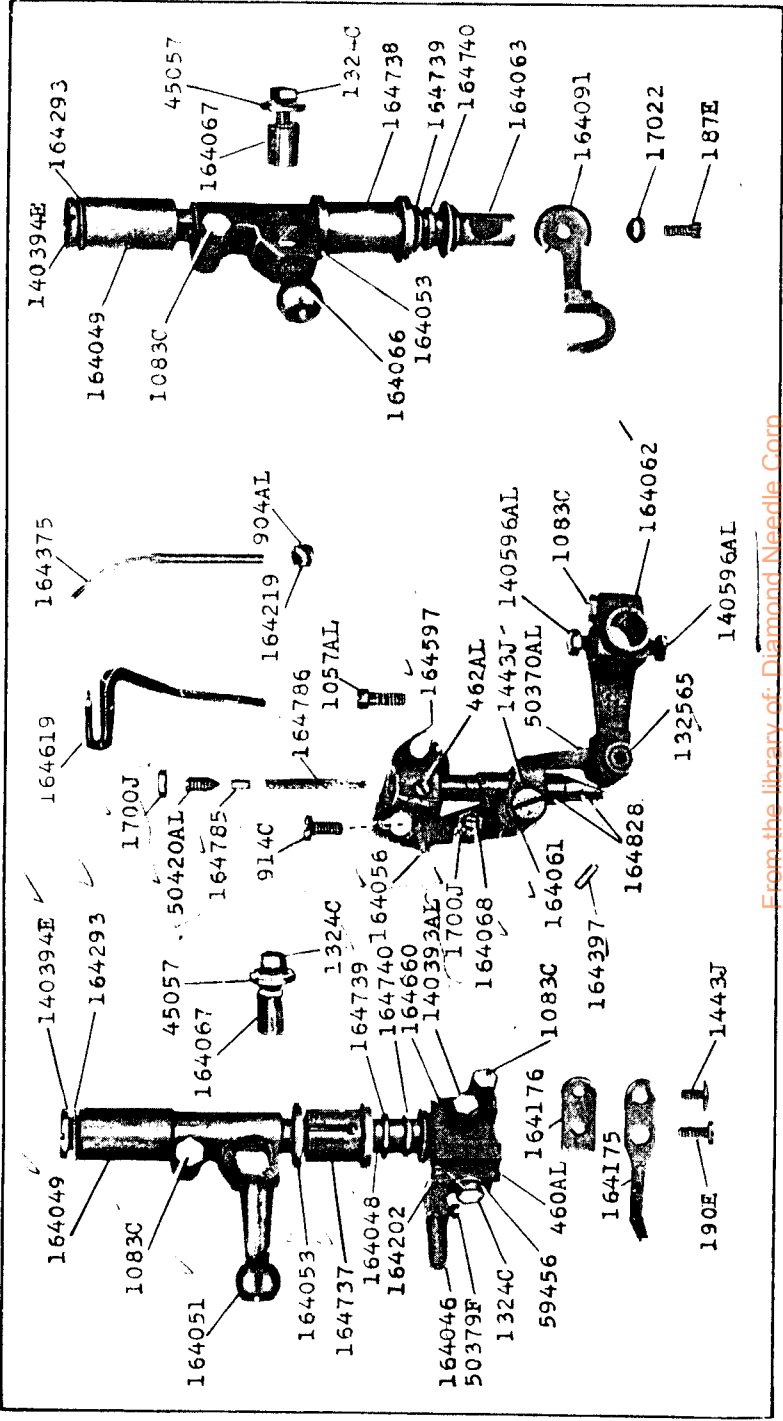

From the library of Diamond Needle Corp

24886 2/3

24887 1/2

164647

164617

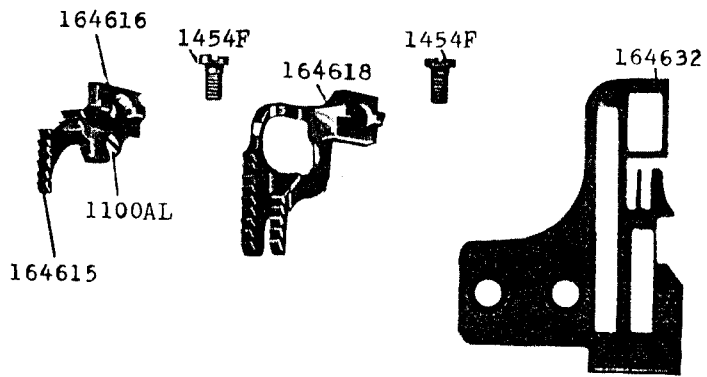

164627

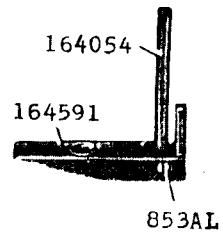
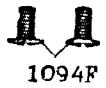
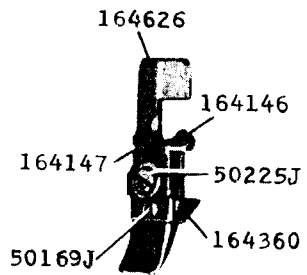

164902
gathering foot
similar to 164548
On 246-13

164617

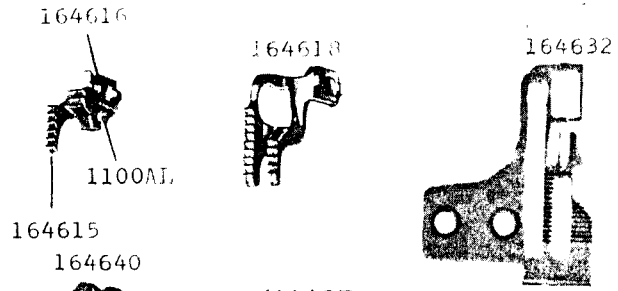

164627

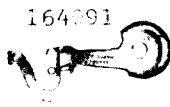
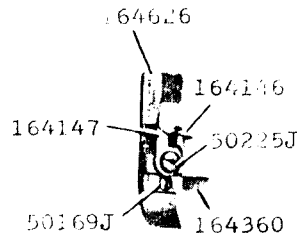

164151

51768C

175132C

164556

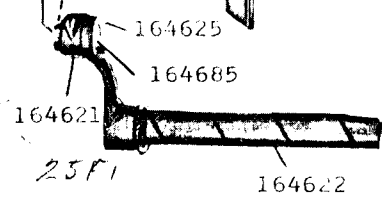

164175

From the library of: Diamond Needle Corp

24888 1/2

164644

164635

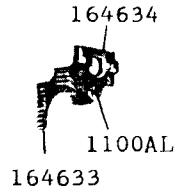

164636



164682

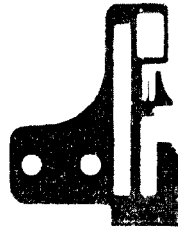

164642

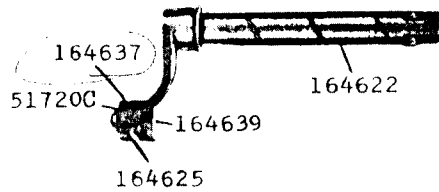
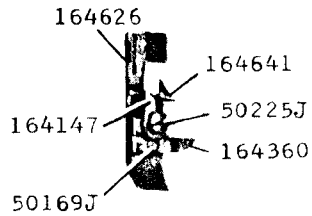

164151



164091



164640



164556



164591



164175



24889 1/2

164677

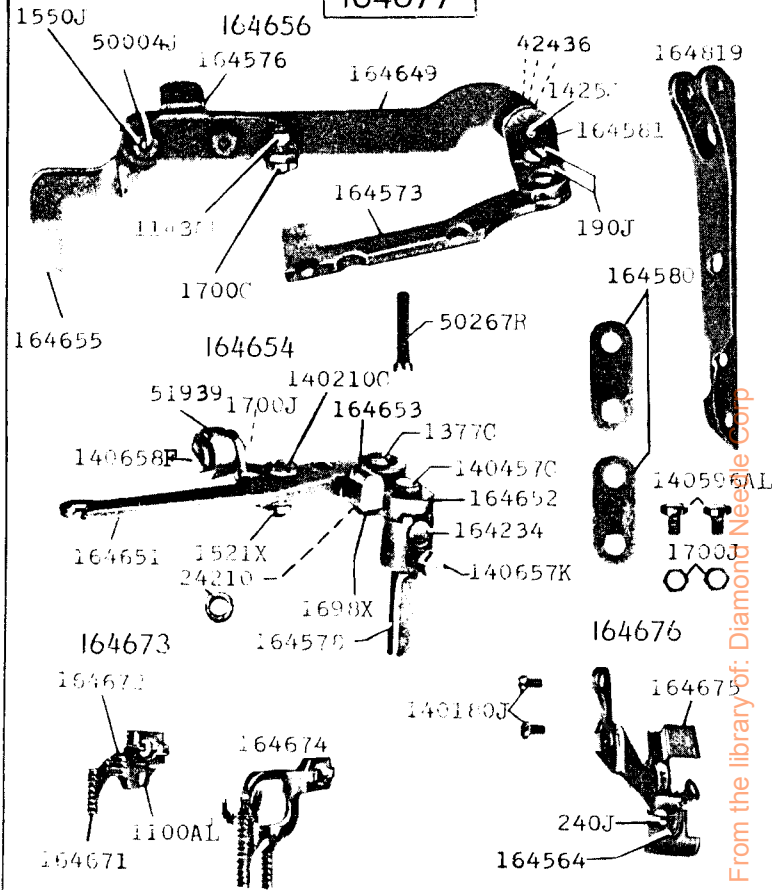

164550

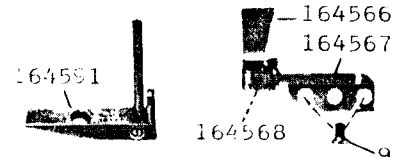

164570



164151



164175



164091 164375



164632

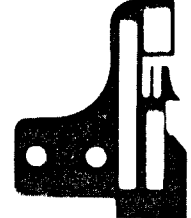

From the library of: Diamond Needle Corp

24890 1/2

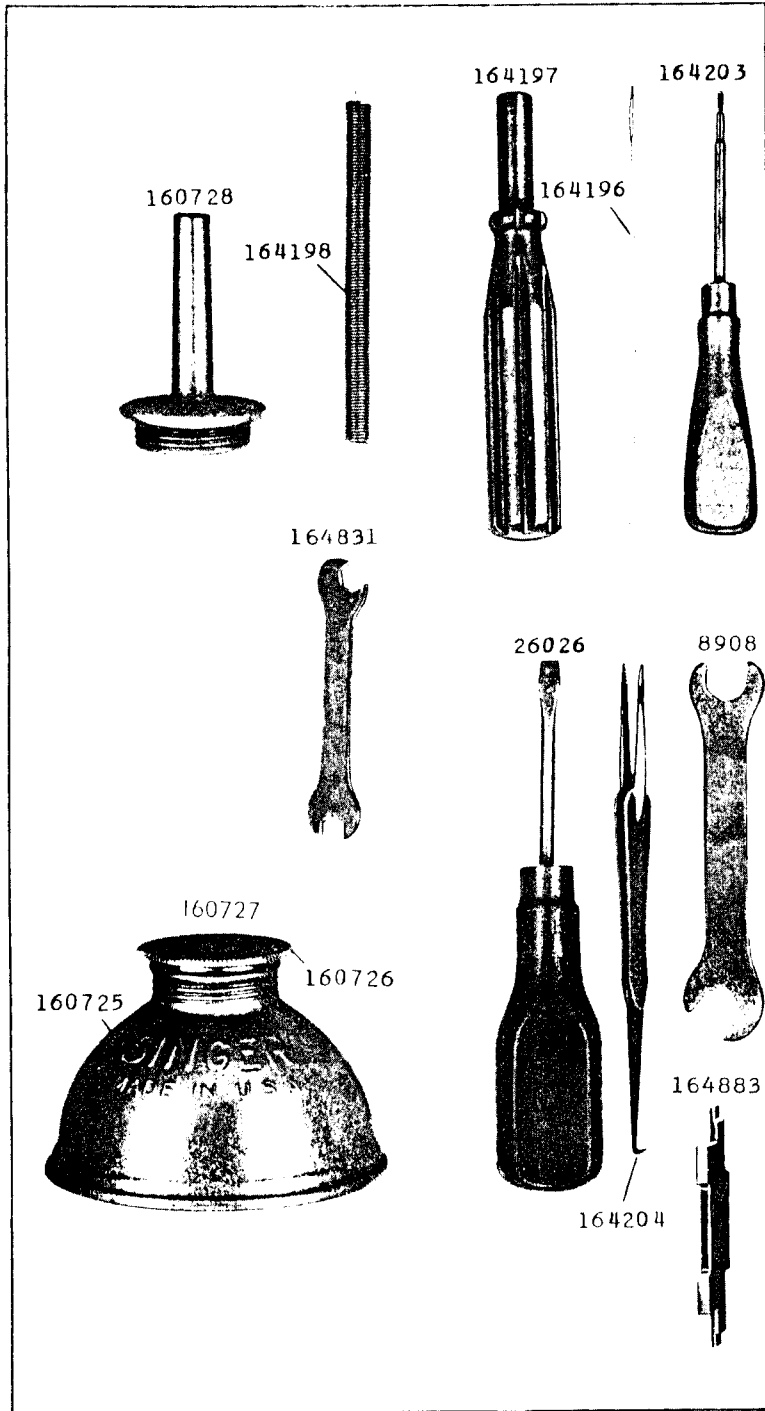

From the library of: Diamond Needle Corp